



**Universal Solar**

# Solar Modules WXS230P-US



## Specifications

Cell Type	Multi-Silicon solar Cells
Cell Size	156mm×156mm (6.14×6.14in)
No. of cells and connections	60(6×10)
Dimension of module(mm)	1640×992×40mm (64.57×39.06×1.57in)
Weight	18.5Kg (40.8lbs)

## Electrical Characteristics

Model	WXS230P-US
Maximum power at STC(Pm)	230W
Open-circuit voltage(Voc)	36.90V
Short-circuit current(Isc)	8.56A
Voltage at Pmax(Vmp)	30.60V
Current at Pmax(Imp)	7.52A

(STC:Irradiance AM1.5, 1000W/m<sup>2</sup>, 25°C)

## Limits

Fuse rating	15A
Maximum system voltage	1000VDC
Operating temperature	-40°F to +185°F (-40°C to +85°C)

## Temperature and Coefficients

NOCT	48°C±2°C
Temp coefficient of Voc	-0.33%/°C
Temp coefficient of Isc	0.046%/°C
Temp coefficient of power	-0.47%/°C

NOCT:Nominal Operation Cell Temperature

## Output

Type of output terminal	Junction box
Cable	12AWG
Cable lengths	1000mm (39.37in)
Connector	Tyco Electronics Solarlok

## Mechanical Characteristics

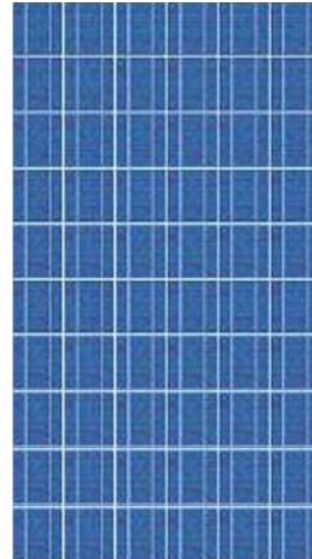
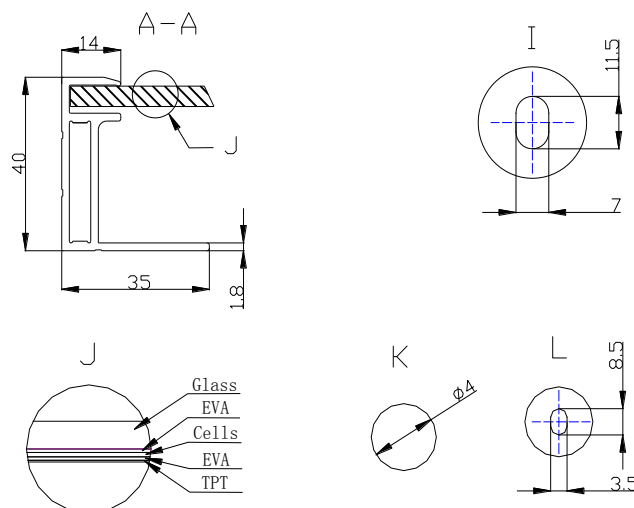
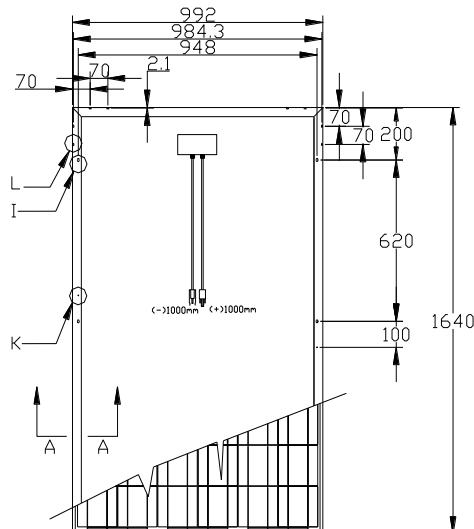

## Characteristics Curve

